

# ALBiDAY

B A G K O K



# BRINGING THE WORLD BACK HOME TO YOU

EMAIL:  
[CONTACT@ALBIDAY.COM](mailto:CONTACT@ALBIDAY.COM)

TEL: 0815441180

LINE ID:  
[@971NRDYI](https://www.line.me/@971NRDYI)

[WWW.ALBIDAY.COM](http://WWW.ALBIDAY.COM)

## WELCOME / EDITOR'S NOTE

ข้อความจากผู้ก่อตั้ง ALBIDAY

## BRINGING THE WORLD BACK HOME TO YOU

คำขวัญ & ปรัชญาแบรนด์

01

## SURFACE THAT SPEAK

วัสดุที่เราหลงรัก: CEMENT, HMR, ไม้สัก

02

## WALL SERIES

URBANESE TEXTURE: CEMENT PANEL & EASY BOARD

03

## FURNITURE SERIES

ชั้นวาง, ตู้, โต๊ะ สำหรับพื้นที่ใช้ชีวิต

04

## ART PANEL SERIES

งานตกแต่งผนัง: BRUTALIST X JAPANESE MOOD

05

## GNC CUSTOM DESIGN SERVICE

เฟอร์นิเจอร์ต้อนรับแบบ CUSTOMIZED

06

## ALTERNATIVE SPACE SOLUTION

SMART FILM

07

## SELECTED PROJECTS

โปรเจกต์จริงและตัวอย่างการใช้งาน

08

## INSPIRATION FROM THE WORLD

TADA0 ANDO, MILAN DESIGN WEEK, ETC.

09

## OUR SERVICES

ออกแบบ, ผลิต, ให้คำปรึกษาแบบครบวงจร

## CATALOG SUMMARY

ตารางขนาดสินค้า, วัสดุ, ราคาขาย

## CONTACT / QR CODE

ช่องทางติดต่อ ALBIDAY

## BEHIND THE PROCESS

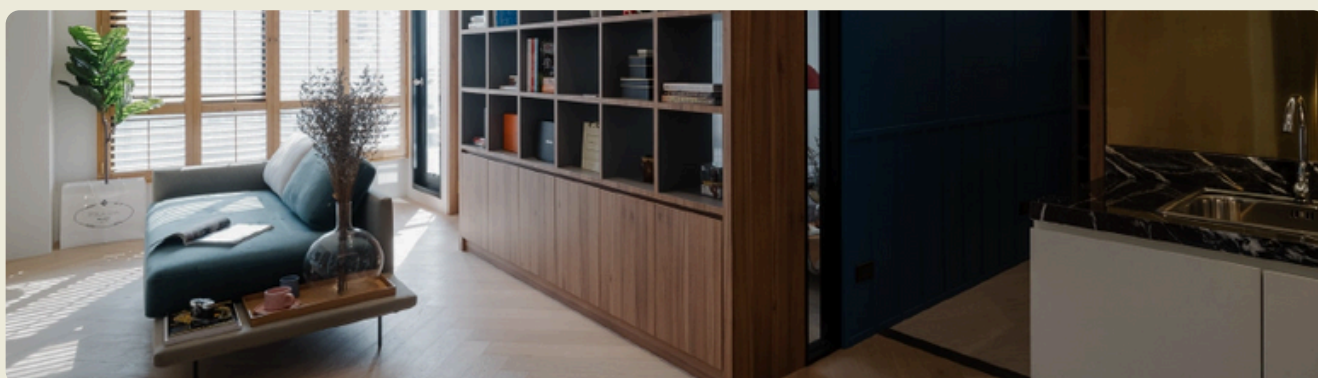

# INTRODUCING A TIMELESS & CONTEMPORARY LIFESTYLE



**ALBIDAY** IS A DESIGN VISION BORN IN THE HEART OF BANGKOK. IN A CITY WHERE TIME NEVER STOPS, WE BELIEVE YOUR SPACE SHOULD.

WE BLEND MODERN SENSIBILITY WITH CLASSIC CALM, CRAFTING FURNITURE AND FINISHES THAT REFLECT YOUR RHYTHM OF LIFE.

WHETHER IT'S A CONCRETE TEXTURE THAT GROUNDS THE SOUL, OR A SHELF THAT TURNS EVERYDAY OBJECTS INTO ART—OUR WORK IS MADE FOR HOMES THAT TELL A STORY.

THROUGH WARMTH, SIMPLICITY, AND MATERIALS THAT AGE BEAUTIFULLY, ALBIDAY BRINGS THE WORLD BACK HOME TO YOU.

[WWW.ALBIDAY.COM](http://WWW.ALBIDAY.COM)

# BRINGING THE WORLD BACK HOME TO YOU

"From textures of concrete in Kyoto to warmth of teak in Chiang Mai, we gather the world's essence into furniture that breathes life into your space."



## **Bringing the World Back Home to You**

In every piece we design, there's a story from somewhere far yet familiar.

From the quiet strength of Kyoto's concrete, to the way teak ages gracefully under Chiang Mai's sun — we collect textures, moods, and feelings across the world to reshape them into something truly yours.

**At ALBiDAY**, we believe design is more than aesthetics. It's the act of returning — to yourself, to stillness, to spaces that hold memory and meaning. That's why we say: we don't just make furniture. We bring the world back home to you.



It's in the quiet geometry of sunken seating, where conversation feels anchored and time slows down. Or in the long corridor framed by volcanic stone and filtered light, where walking through a space feels like stepping into a memory. These aren't just architectural gestures — they are emotional invitations. Reminders that your home can hold both design and feeling in the same breath.

**ALBiDAY** draws inspiration not only from the world's textures, but also from its cultures of stillness — the way Japanese homes choreograph light and shade, or how Thai verandas extend life toward the garden.

Our pieces seek to translate those values into modern living — to give you a place where the world outside informs, but never overwhelms, the world within.

This is how we bring the world back home to you.

*Wiwittha Piyapattanakul*  
**FOUNDER**

# SURFACES THAT SPEAK

01

Every surface we choose tells a story of tactility, culture, and timelessness.



CEMENT PANEL



HMR / MDF



YOUNG TEAK



At ALBiDAY, materials are more than what you touch — they're how you feel.

We choose cement not because it's strong, but because it remembers. It records shadows, scratches, and sunlight like pages of a lived-in journal.

HMR panels — clean, light, adaptable — remind us of order and rhythm in urban living. While aged teak breathes warmth into sharp spaces, like a quiet soul in a modern city.

These aren't just materials. They're memory keepers.

And every piece you bring home carries a part of the world, the way we remember it.

"Cement is not cold. It just remembers silence better."

# WALL SERIES

URBANESE TEXTURE  
CALM AND SOLID FEELIN'



02



# URBANESE TEXTURE RAW YET REFINED.

Our cement panels reinterpret brutalism for modern interiors – quietly bold, tactile, and effortlessly architectural

## Choose between:

- Cement Panel (Dark) – real cement surface with warm tone
- Easy Panel (Light) – lighter weight, for vertical applications

Designed for lofts, cafes, retail, and homes that seek character without excess.

### CEMENT PANEL CB-102

Wide x Length: 90 x 90 cm.  
Thickness: 1 cm.  
Weight: 7 kg.

1,500 THB

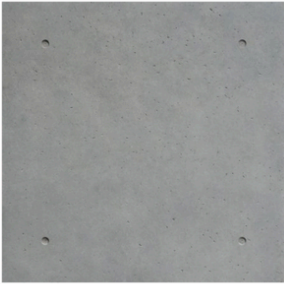

### EASY C PANEL WEB-102

Wide x Length: 90 x 90 cm.  
Thickness: 1 cm.  
Weight: 6.5 kg.

1,400 THB

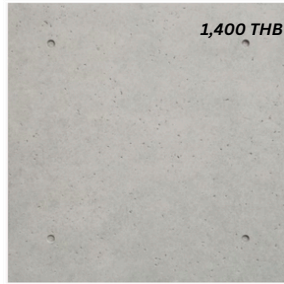

### CEMENT PANEL CB-104

Wide x Length: 60 x 90 cm.  
Thickness: 1 cm.  
Weight: 4.5 kg.

980 THB

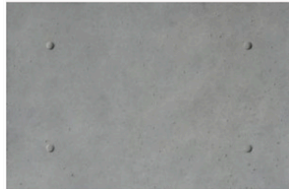

### EASY C PANEL WEB-104

Wide x Length: 60 x 90 cm.  
Thickness: 1 cm.  
Weight: 4.5 kg.

900 THB

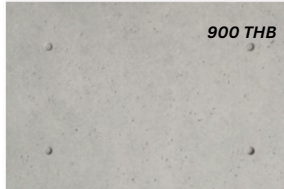

## Product Material Collaboration:

At ALBiDAY, meaningful design begins with strong partnerships.

With Oranit Co., Ltd., Thailand's leading cement board maker, we craft panels that unite strength and timeless beauty.

We thank all partners who bring these creations to life.



# FURNITURE SERIES

Everyday  
Objects,  
Elevated

03

AFFORDABLE CRAFTSMANSHIP & DESIGN FOR DAILY RITUALS

# EVERYDAY OBJECTS, ELEVATED.

Everyday Objects, Elevated.

We believe a shelf isn't just storage — it's a frame for your life.

Our furniture blends lightness, structure, and rhythm.

Built from HMR, teak offcuts, and matte-finish laminates, each piece is made with thoughtful proportion and a quiet presence.

Whether it's a floating console, a stepped cabinet, or a traditional & modular table — we craft furniture to support modern rituals, without screaming for attention.





# SCULPTED CALM - THE ART OF SILENT FUNCTIONALITY

## WHERE EVERY OBJECT KNOWS ITS PLACE – AND ITS PURPOSE.



### 01 | The Restful Tactility

**Brutalism softened by intimacy.**

The bedroom features a tactile charcoal brick accent wall that anchors the space with textural depth, evoking a quiet brutalist influence. Balanced with a soft upholstered headboard framed in natural wood, the bed itself feels both inviting and precise.

Layered linens in muted tones provide visual warmth, while mid-century side tables and black dome lamps punctuate the space with intention. Framed by a full-height view of the Bangkok skyline, this room embodies understated indulgence — where the city stays outside, and stillness begins inside.

### 02 | The Living Composition

**Where marble meets geometry.**

In this serene living space, bold shelving meets the quiet luxury of marble-clad surfaces. The open grid cabinetry plays with negative space, giving rhythm and relief to an otherwise clean vertical plane.

Underneath, the floating credenza blends warm oak tones with sleek integrated surfaces, complementing the tactile contrast of the modern textile lounge chair. Every element whispers functionality — from sculptural decor to the symmetry of the TV setup — crafting a room where order and calm coexist.



# **ART PANEL SERIES**

**From Texture  
to Totem**

**04**

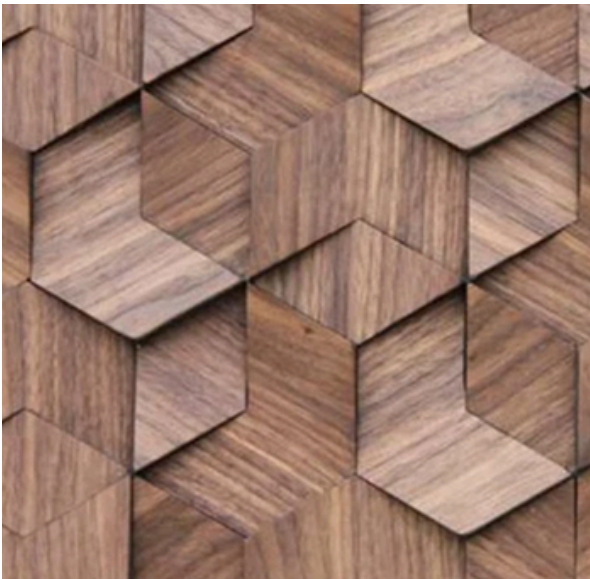
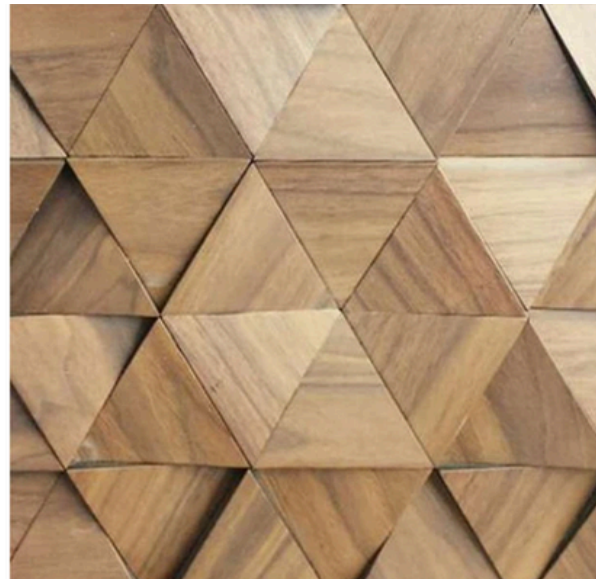
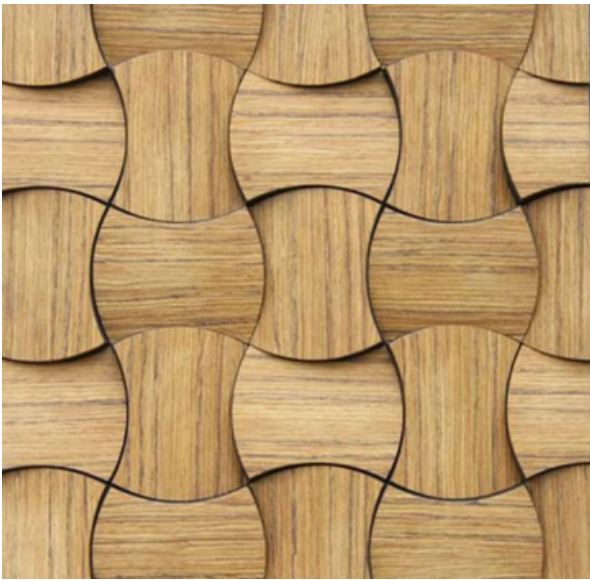

**“EVERY PANEL CARRIES  
A SILENCE THAT SPEAKS  
LOUDER THAN FORM.”**

At ALBiDAY, we believe walls deserve more than paint.

Our Art Panel Series brings meaning back to the surface — drawing from shadows, folds, and ancient motifs to shape panels that speak without saying a word.

Inspired by sculptors, textile artisans, and the humble geometry of nature, these panels are not backdrops. They are the quiet centerpieces of a room.



### ***Textural Stillness in Everyday Corners***

Just beyond the clinking glasses and the last echo  
of footsteps,  
a wall quietly holds the room together — not  
with force,  
but with memory.  
This woven bamboo panel, aged just enough to  
forget its symmetry,  
whispers of craftsmanship passed through  
hands, not machines.

Its rhythm, neither loud nor repetitive, allows  
light to slide softly across its texture.  
Not ornamental — but elemental.

Here, structure becomes ritual.  
The wall doesn't just divide; it slows you down.  
It teaches you how to look, and how not to speak  
too soon.



# CUSTOM CNC DESIGN SERVICE

**MADE TO MEASURE.  
DESIGNED BY YOU, CRAFTED  
BY ALBiDAY.**

*Your idea deserves to be real.  
Let us cut it into form."*

**05**

Whether you're an architect with a bold idea, or a café owner in search of a one-of-a-kind piece — we are here to build it with you.

ALBiDAY offers custom CNC fabrication services, capable of translating your sketches and renderings into fully realized pieces.

Working with a trusted factory equipped with high-precision CNC machines, we specialize in cutting and finishing HMR boards enhanced with Laminate or PVC Membrane finishes.

From decorative panels to reception counters, every edge, layer, and groove is crafted with care — reflecting not only your design, but your vision.



# What We Offer

01



## Design-to-Production

- From moodboards and sketches to CAD and prototypes
- We help refine your concept into a precise production file
- Ideal for architects, interior designers, and branding studios

02



## Accept Your Own Design File

- Send your drawings (.dwg, .skp, or vector format)
- We'll quote the material cost, production time, and finishing options
- CNC cutting available for HMR, Cement Board, and Plastwood

03

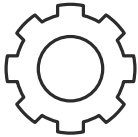

## Finishing Options

- PVC Membrane Press
- High Pressure Laminate (HPL)
- Clear or Color Coating
- Optional Surface Texturing (custom request)

## Additional Notes

- Supports both small items (wall panels, signage) and large-scale builds (reception desks, retail counters).
- If you don't have a design yet, we can sketch it for you — no charge for first concepts.
- Especially suitable for interior designers, boutique hotels, galleries, cafés, and studios.

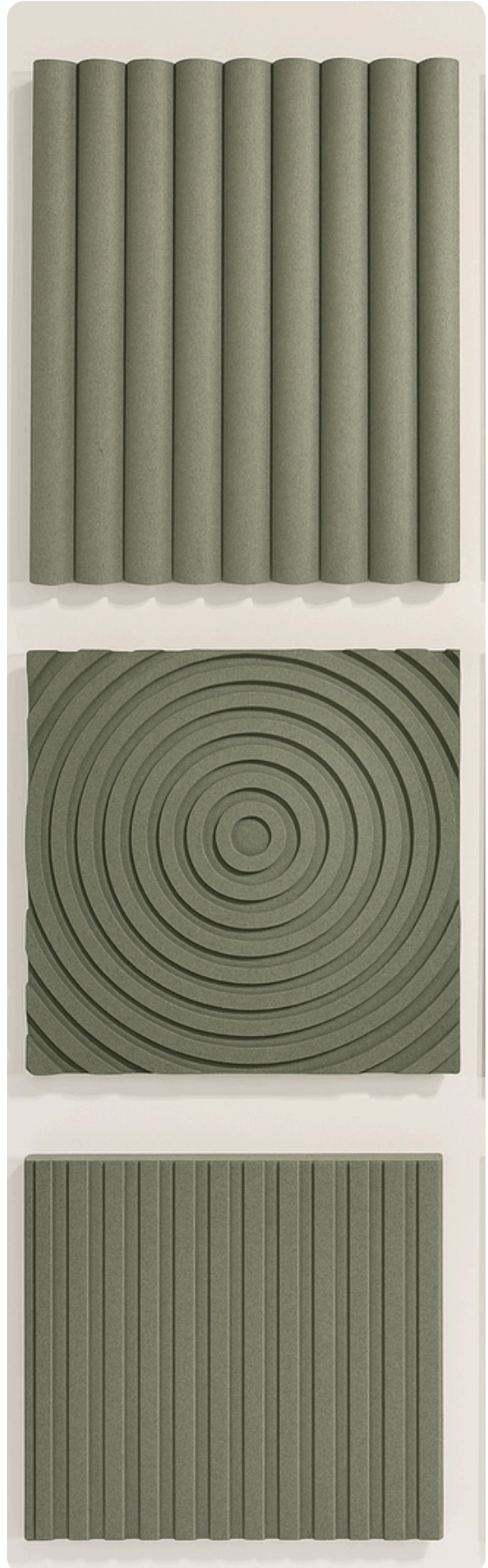

# CNC Pattern Series

Explore the Possibilities of Form & Rhythm in Custom Design

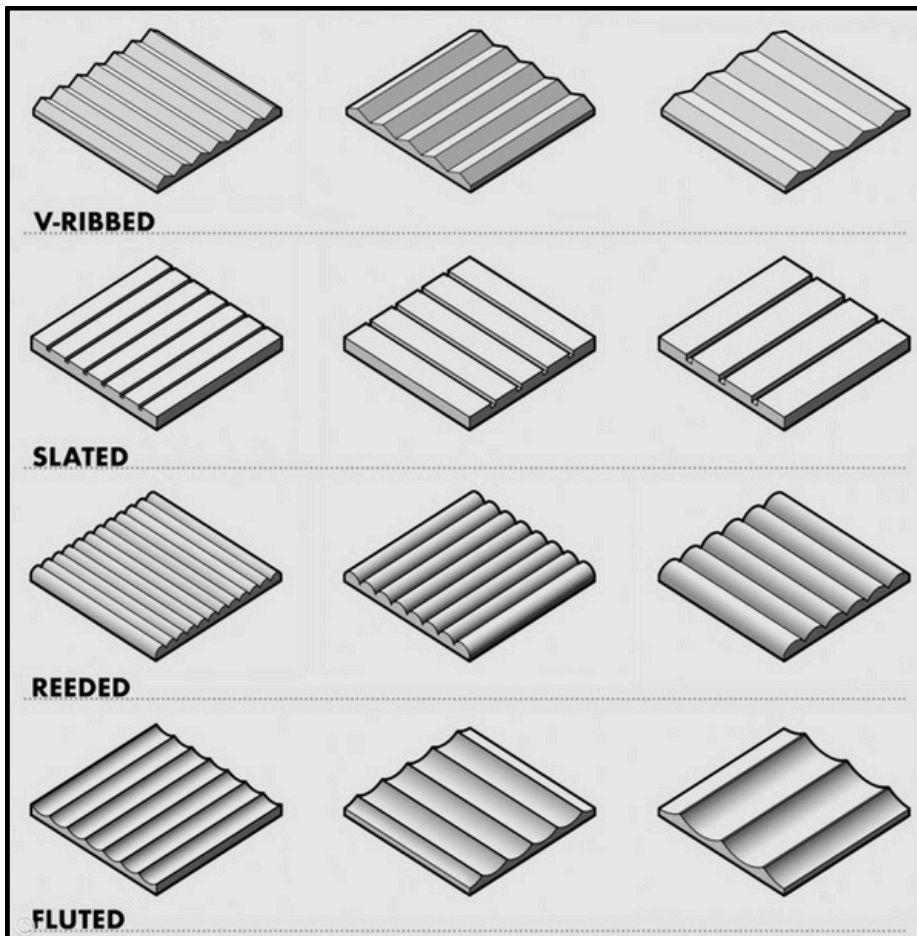

Our CNC capabilities allow you to shape architectural surfaces with clarity and rhythm. From sharp grooves to soft curves — your patterns define the atmosphere.

Each material brings a different tactile and visual quality to your CNC design. Let us help you choose the right surface for your purpose.

## Material Options Table

| Material     | Thickness Range | Recommended For               |
|--------------|-----------------|-------------------------------|
| HMR/MDF      | 6–25 mm         | Interior panels, cabinets     |
| Cement Board | 6–12 mm         | Wall cladding, signage        |
| Plastwood    | 3–20 mm         | Lightweight decorative panels |

Looking to prototype or build in bulk?  
Send us your sketches or digital file, and we'll shape it into form — precision guaranteed.



Photo by: [www.archdaily.com](http://www.archdaily.com)  
V-RIBBED EARTH TONE



Photo by: [www.archdaily.com](http://www.archdaily.com)  
FLUTED CUSTOMIZE



Photo by: [www.archdaily.com](http://www.archdaily.com)  
SLATED WOOD



Photo by: [www.archdaily.com](http://www.archdaily.com)  
REEDED OFFWHITE

# ALTERNATIVE SURFACE SOLUTION

06

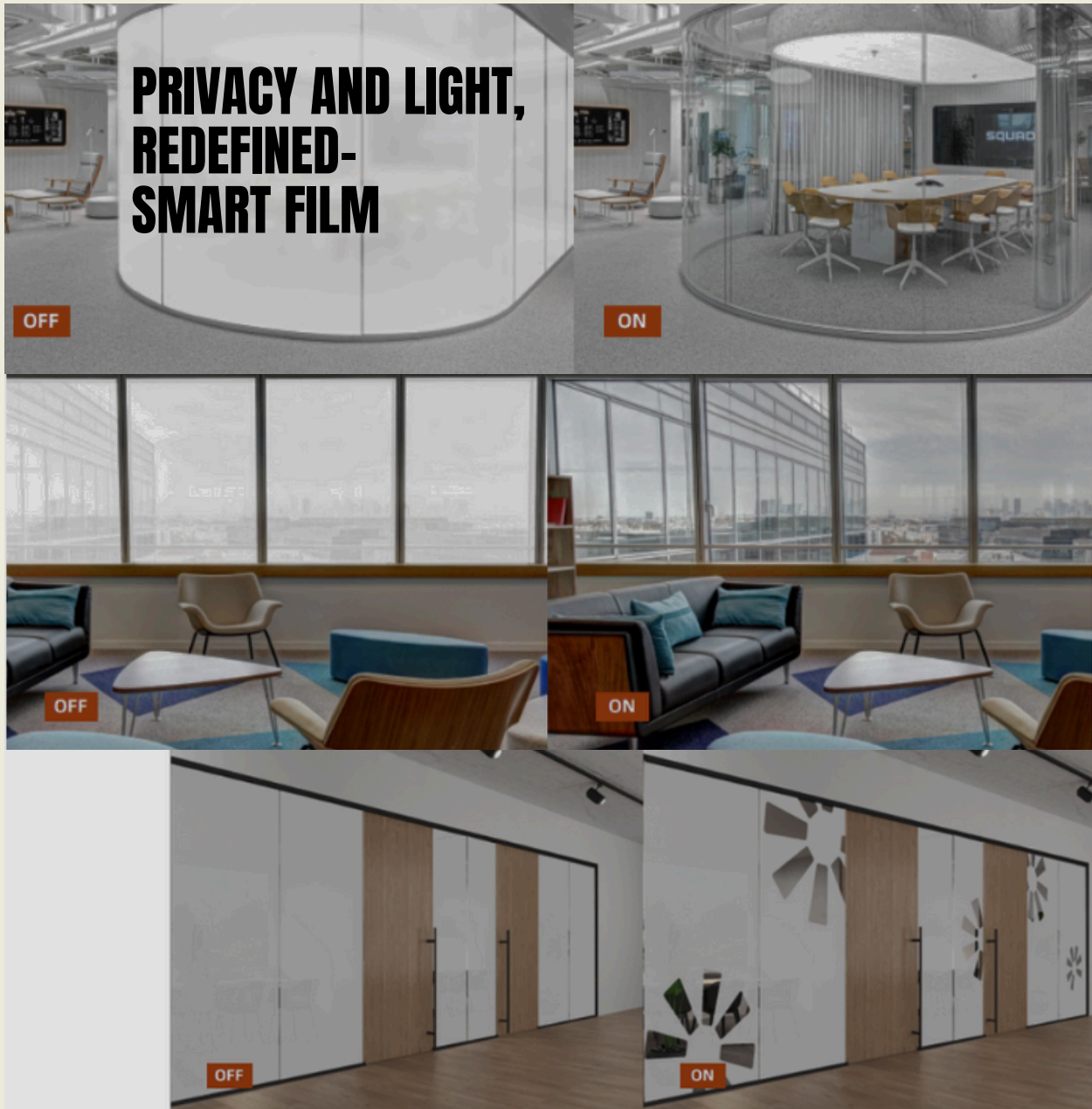

**Smart Film** technology offers a modern and versatile solution for transforming any glass surface into a multifunctional space. With a simple switch, the film shifts from opaque to transparent, providing both privacy and openness as needed.

# Technical Principles

## PDLC Film

PDLC (Polymer Dispersed Liquid Crystal) film is a new material electronic light control product that allows the user to control the perspective of the glass and the intensity of the light with very little energy, by injecting a liquid crystal/polymer hybrid material injected in the middle of two transparent conductive films.

PDLC film in the absence of an electric field, the electronically controlled PDLC FILM is in an opaque state.

When an alternating current is applied, the liquid crystal molecules are arranged in an orderly manner, at which point the PDLC film changes from an opaque state (OFF) to a transparent state (ON).

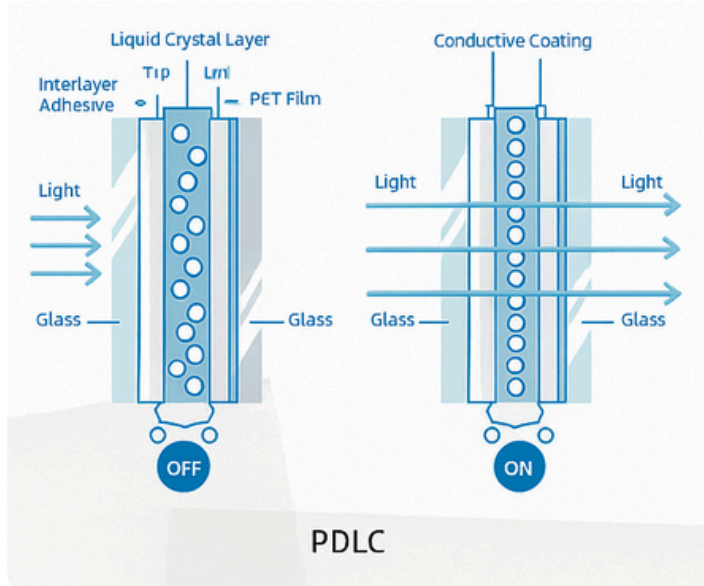

# Two types

## PDLC Film

There are two types of PDLC films, self-adhesive film and adhesive film for front-end design and post-retrofit projects.

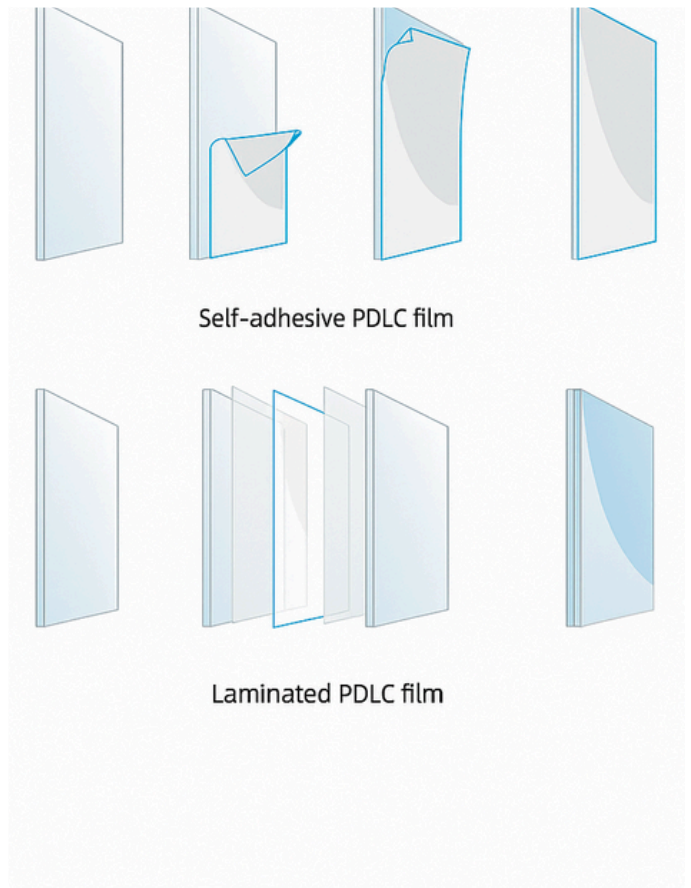



Privacy protection



Security

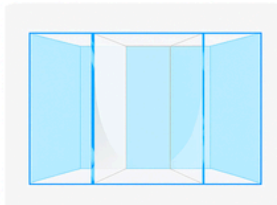

Space partition

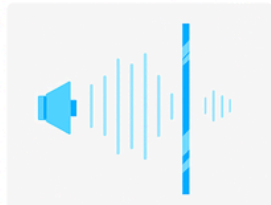

Anti-noise



Environmental protection

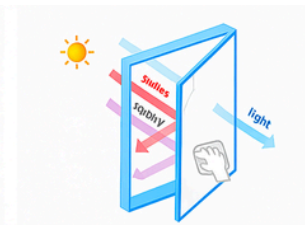

Heat-resistant and anti-scratch



Touch screen and projection



Various control methods

## Available Products

- Self-Adhesive Smart Film (for retrofit applications)
- Non-Adhesive Smart Film (for glass lamination during production)
- Color-Tinted Smart Films (optional)
- Cut-to-Size or Roll-Based Options

## Key Benefits

- Privacy on Demand – Switch between transparent and frosted with a click.
- UV & IR Protection – Blocks over 98% of harmful UV and infrared rays.
- Energy Efficiency – Reduces interior heat gain, improving air conditioning efficiency.
- Projection Compatibility – Functions as a rear-projection screen for presentations or branding.
- Space Flexibility – Ideal for offices, hotels, residences, and showrooms.

## Product Specifications

- Thickness: 0.38–0.50 mm
- Operating Voltage: AC 48V–65V
- Visible Light Transmittance: 82% (On) / 63% (Off)
- Haze: <6% (On) / >92% (Off)
- Response Time: <10 ms
- Operating Temperature: -20°C to +60°C

## Usage Recommendations

### Smart Film is suitable for:

- Meeting Rooms & Offices
- Glass Partitions in Homes & Condos
- Hotel Bathrooms with Privacy Modes
- Commercial Displays and Pop-Up Installations
- Retail Windows and Interactive Showcases

**Note:** Prices are not displayed in this edition. Please contact ALBiDAY for updated quotations based on your location and requirements.



# FILMBASE 091

FILMBASE 001 is the luxury PDLC film in the tony market. with 90%~92% transmittance, <2% haze, which maximizes the clarity of the original glass and enhances privacy.

It is used in-scientific research institutions, Intelligence-agencies, luxury villas, president's office, super & star hotels. Hollowood theaters, and other places that require ultra transparency and absolute privacy.

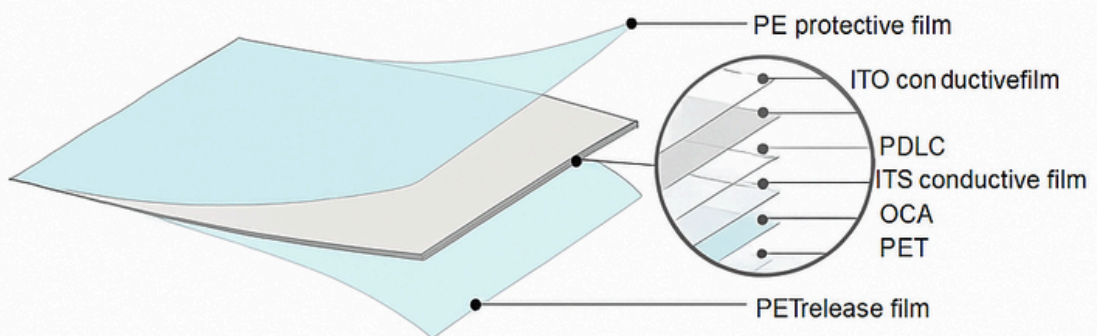



# FILMBASE 085

085 is Filmbases most cost effective item Nice be 44-86% Transmittance and nice 4-5% hazz, which is vèlcome by the projects dons not request super high transparency and haze applications.

It is suitable for modern office partitions, space partitions, dillege halls, museums, exhibition centers, space hotels, bars, husmaido, panor ohter places that require Integrate teransparency, partition

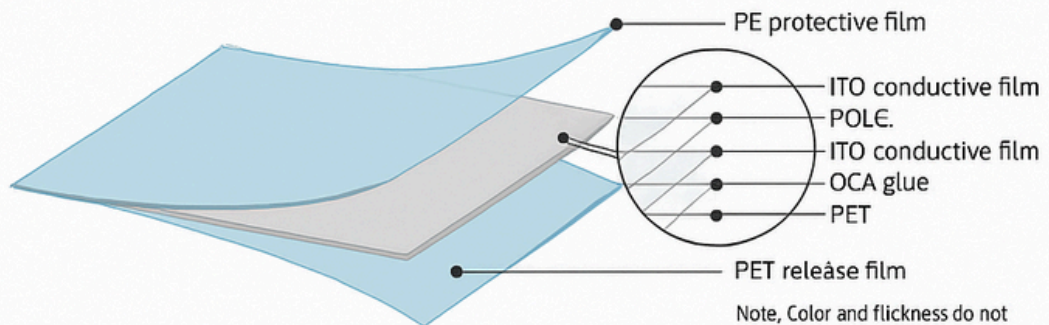

Note, Color and flickness do not represent this actual situation. ultor for converence for



# FILMBASE Reverse

Filmbase Reverse film is a special transparent liquid crystal film, can be sandwiched in the glase or adhesive on the glass, become opaque when power on, can be widely used in space partition, electronic products, automotive fields ,can be sandwiched into the glass or Adhesive onto the exited glass.

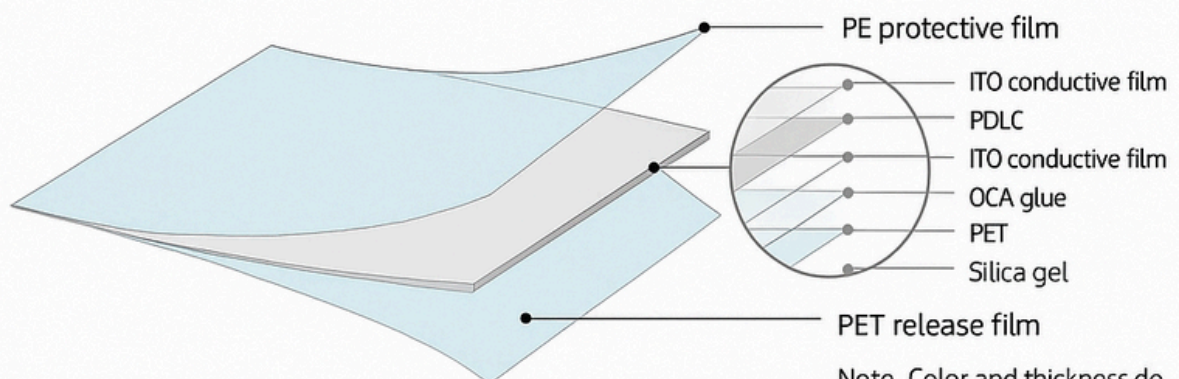

# SELECTED PROJECTS

**“WHERE IDEAS BECOME  
PLACES”**

*Real materials, real clients, real stories.*

Every project we accept is not just a brief.  
It's a beginning.

Whether it's a small reception desk in a café,  
or a full wall installation for a boutique hotel,  
we listen deeply — to the site, the user, and the  
unspoken moods within the space.

These selected projects reflect our process:  
thoughtful materials, honest craftsmanship, and  
a quiet confidence in detail.

**07**

**“DESIGN ISN'T WHAT WE  
INSTALL. IT'S WHAT  
REMAINS AFTER.”**  
**“WE BUILD SPACES THAT  
BREATHE WITH YOU.”**



White on Block Co. (Construction)



White on Block Co. (Construction)



White on Block Co. (Construction)

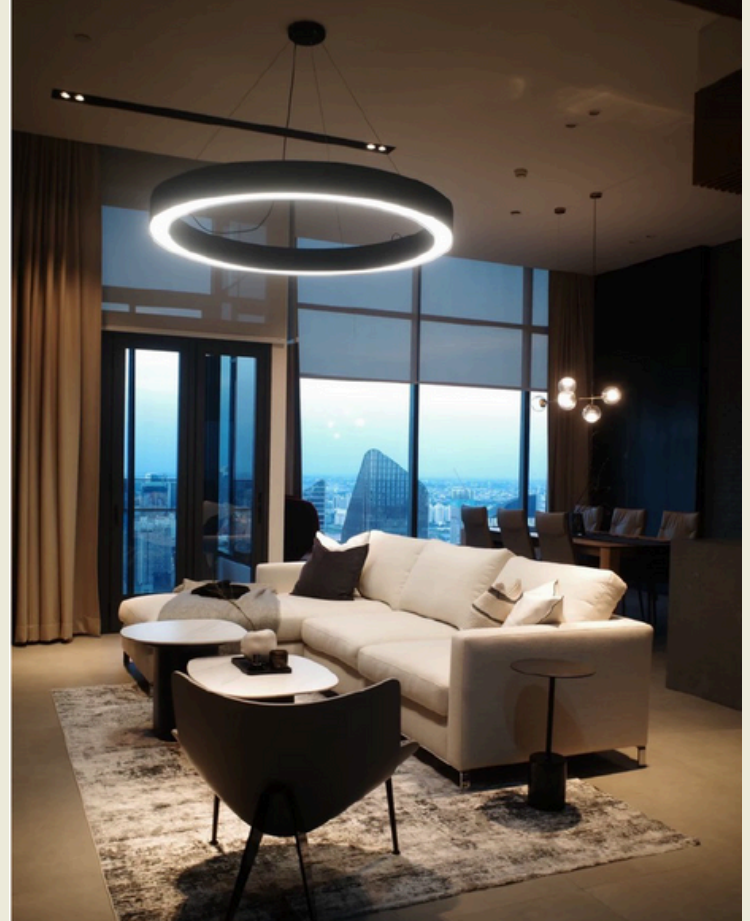

White on Block Co. (Construction)



White on Block Co. (Bult-in Furniture)

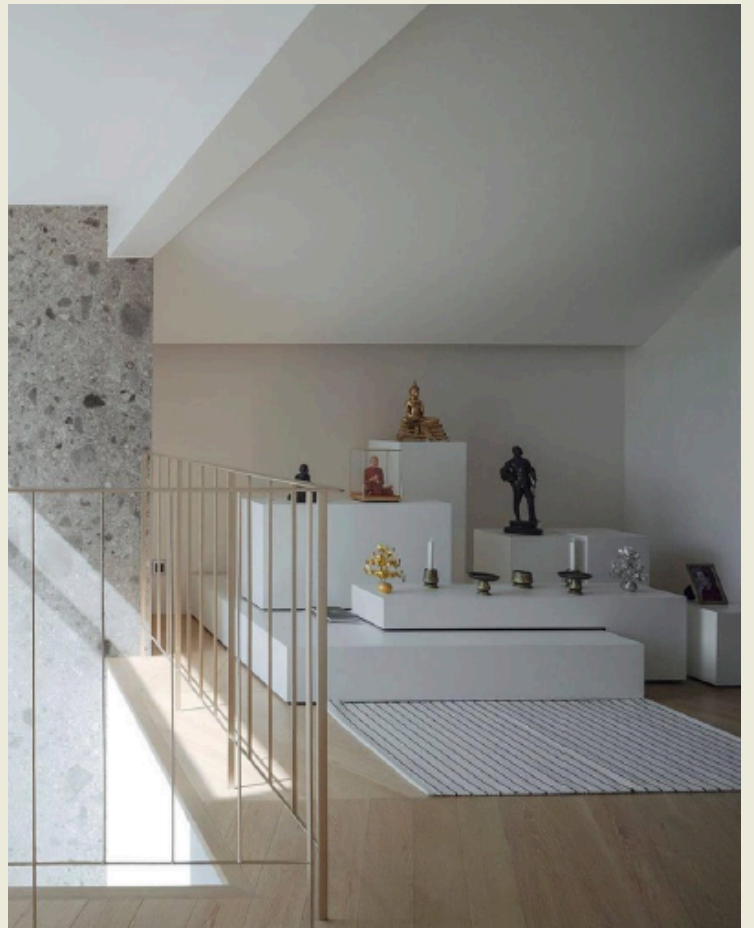

White on Block Co. (Bult-in Furniture)



White on Block Co. (Bult-in Furniture)

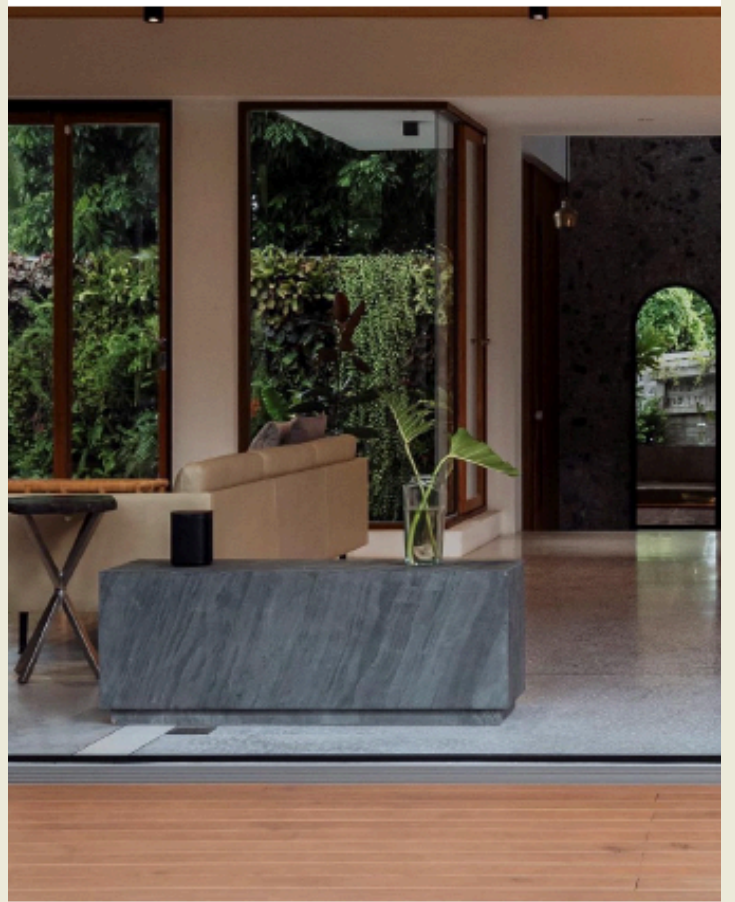

White on Block Co. (Bult-in Furniture)



White on Block Co. (Bult-in Furniture)



White on Block Co. (Bult-in Furniture)



White on Block Co. (Built-in Construction)



White on Block Co. (Built-in Construction)



White on Block Co. (Design & Construction)



White on Block Co. (Design & Construction)



White on Block Co. (Design & Construction)



White on Block Co. (Design & Construction)



White on Block Co. (Design)



White on Block Co. (Design & Construction)  
ARAKSA TEA ROOM BANGKOK



White on Block Co. & RIAB Co. (Build-in & Construction)

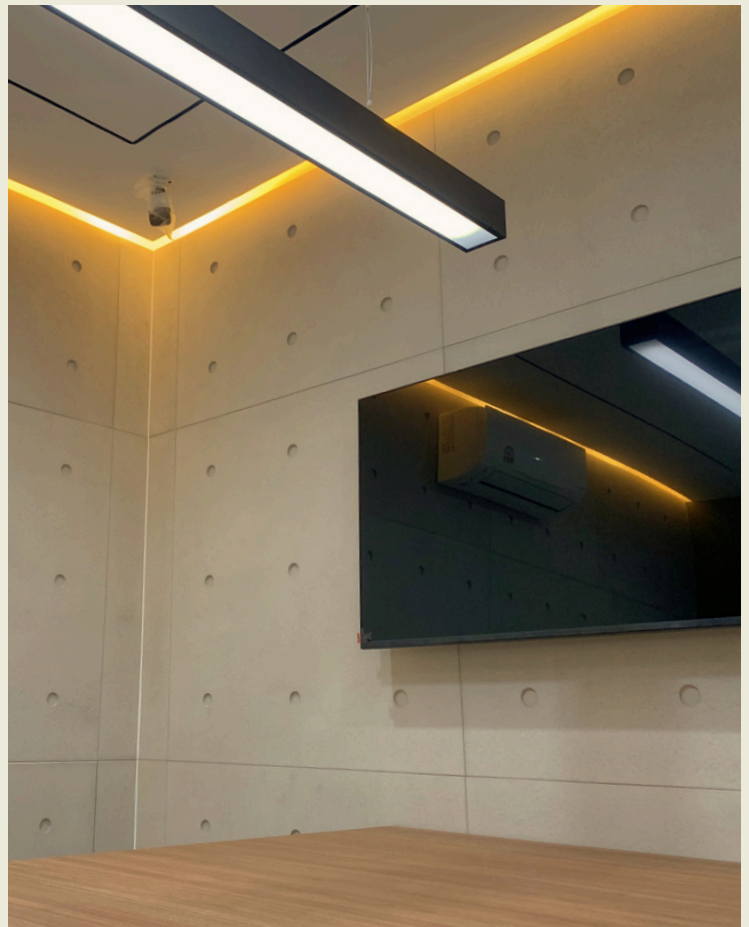

White on Block Co. & RIAB Co. (Build-in & Construction)

# INSPIRATION FROM THE WORLD

WHERE STORIES OF PLACES BECOME OBJECTS OF LIVING EVERY PIECE  
BY ALBIDAY BEGINS WITH A WHISPER FROM A CITY, A WALL, OR A  
CULTURE FAR AWAY.

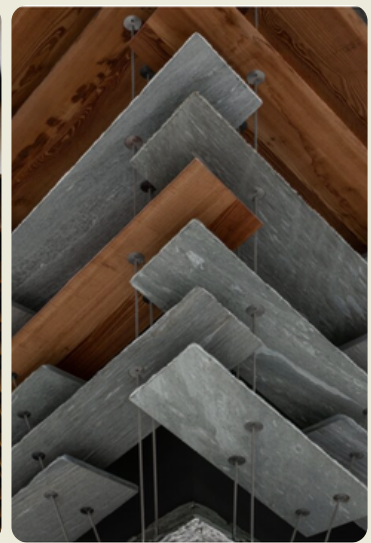
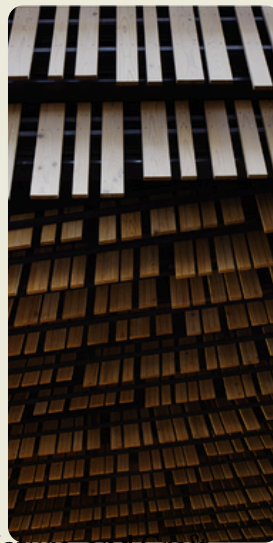

Inspired from the World

The Quiet Power of Design — from Concrete, Nature, and Craft

Inspired from the World

The Quiet Power of Design — from Concrete, Nature, and Craft

08

# ANDO TADAO

The Geometry of Human Space



Inspired from the World  
The Quiet Power of Design — from Concrete, Nature, and Craft

Information by **TASCHEN**

# KUMA KENGO

Beauty of Stone, Wood, and Glass at Haus Balma

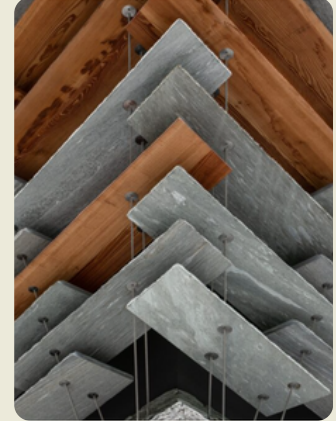

Inspired from the World  
The Quiet Power of Design — from Concrete, Nature, and Craft

Information by D5 DESIGN MAGAZINE

# MASTERS OF MATERIAL & SPACE

*A Tribute to Ando Tadao & Kengo Kuma*

## **Ando Tadao (b. 1941 – Osaka, Japan)**

A self-taught architect with a poetic sense of silence and solidity, Tadao Ando is globally renowned for his mastery of concrete, light, and shadow. His journey began not in academia, but through studying architecture independently after a career in boxing and traveling across Europe and the United States. Influenced by Le Corbusier and Zen philosophy, Ando's designs embody minimalism, serenity, and spiritual depth.

His signature use of bare concrete, precise geometry, and light-filled voids creates contemplative spaces that transcend function. Projects like the Church of the Light, Naoshima Art Site, and Row House in Sumiyoshi reflect his belief that architecture should resonate with the soul.

For ALBiDAY, Ando's philosophy is more than a design reference—it's a way of thinking. His devotion to "creating emptiness" inspires our cement panel designs, inviting quiet beauty into the everyday.

## **Kuma Kengo (b. 1954 – Yokohama, Japan)**

Where Ando embraces concrete, Kengo Kuma celebrates the tactile, the fragile, and the vernacular. A graduate of the University of Tokyo and Columbia University, Kuma's philosophy emphasizes "architecture that disappears"—designs that blend with nature, echo tradition, and honor local materials.

Kuma's works, such as the Asakusa Culture Tourist Center, V&A Dundee Museum, and the Japan National Stadium, are known for layering bamboo, wood, stone, and translucent fabrics into gentle forms. His deep respect for craft and context makes his architecture both modern and timeless.

At ALBiDAY, Kuma's humanistic approach aligns with our own values—especially in our use of HMR panels, wooden textures, and geometric rhythm. His sensitivity to light, air, and culture continues to guide how we develop materials that are inspired by the land and tailored to life.

# OUR SERVICES

# 09

## FROM VISION TO REALITY - A FULL-SERVICE CREATIVE PARTNER

Design. Fabrication. Consultation.  
Whether you're building a boutique, hotel,  
café, or a private home,

ALBiDAY provides end-to-end services —  
from ideation to installation.



### 1. Design & Conceptualization

We help shape your imagination into tangible concepts. Our design service supports:

- Interior concepts, custom furniture, and decorative panels
- CNC-ready surface design (parametric, traditional, or architectural style)
- Material pairing and color consultation

### 2. Fabrication & Material Solutions

With our partner factory and CNC system, we bring your designs to life through:

- CNC carving on HMR, MDF, Cement Board
- Laminating with PVC Membrane or High-Pressure Laminate
- Customizable finishes for interior & exterior use

### 3. Consultation & Collaboration

We're more than makers. We're your design companion:

- Personalized advice for architects, designers, and property owners
- Prototyping and sample development
- Sourcing & budget planning based on your brief



IDEA



SKETCH

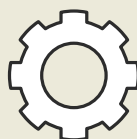

MACHINING



FINISHING



HANDOVER

# CATALOG SUMMARY: CEMENT & CNC PANEL SERIES (Q1/2025)

PRICE INCLD. VAT 7%

| Product Type         | Size (cm)       | Material                     | Surface Finish        | MOQ | Price/Unit (THB) |
|----------------------|-----------------|------------------------------|-----------------------|-----|------------------|
| Cement Panel (Dark)  | 90 x 90         | Cement                       | Natural Matte         |     | 1,490            |
| Cement Panel (Dark)  | 60 x 90         | Cement                       | Natural Matte         |     | 970              |
| Cement Panel (Dark)  | 30 x 90         | Cement                       | Natural Matte         |     | 480              |
| Cement Panel (Light) | 90 x 90         | Easy Cement                  | Natural Light Grey    |     | 1,390            |
| Cement Panel (Light) | 60 x 90         | Easy Cement                  | Natural Light Grey    |     | 900              |
| Cement Panel (Light) | 30 x 90         | Easy Cement                  | Natural Light Grey    |     | 450              |
| CNC - V-RIBBED       | 120 x 240       | MDF/HMR/Plastwood/<br>CEMENT | Laminate/PVC/Melamine |     | 2,550            |
| CNC - SLATED         | 120 x 240       | MDF/HMR/Plastwood/<br>CEMENT | Laminate/PVC/Melamine |     | 2,550            |
| CNC - REEDED         | 120 x 240       | MDF/HMR/Plastwood/<br>CEMENT | Laminate/PVC/Melamine |     | 2,550            |
| CNC - FLUTED         | 120 x 240       | MDF/HMR/Plastwood/<br>CEMENT | Laminate/PVC/Melamine |     | 2,550            |
| Custom CNC Design    | Based on Design | MDF/HMR/Plastwood/<br>CEMENT | Laminate/PVC/Melamine |     | Request Quote    |

## REMARKS:

- Prices may vary depending on material type, surface finish, or special design requirements (deep CNC, curved surfaces, or custom mockups).
- Production lead time: Minimum 3 business days.
- We accept design files in AI, PDF, CAD format — or even hand sketches — for pricing and production evaluation.



**DOWNLOAD  
PDF CATALOG**



**TEL: 081-544-1180**

**EMAIL: CONTACT@ALBIDAY.COM**

**LINE ID: @971NRDY**

# BEHIND THE PROCESS



## RIAB Co.

### Special Thanks to Our Production Partners

Ban extension of this legacy, is a dedicated furniture production facility focused on built-in cabinetry and outdoor furniture. With precision craftsmanship and advanced production capability—including CNC machinery and membrane lamination—RIAB ensures each product meets both aesthetic and structural excellence.

Together, these two entities bring design ideas to life—from concept to creation—helping ALBiDAY deliver solutions that are not only beautiful but also buildable.



## WHITE on BLOCK Co.

### Crafted in Collaboration with People We Trust

Behind many of the beautifully crafted interiors featured in this catalog stands a partnership rooted in over a decade of design and production experience.

White on Block Co. is the original design studio established by the founder of RIAB Co., specializing in interior construction, styling, and project management. With more than 10 years of experience across residential homes, cafés, and condominiums, the company has worked hand-in-hand with designers and contractors to realize thoughtful, well-crafted spaces. From custom design consultation to on-site execution, the team provides comprehensive support for projects of all scales.



## DOWNLOAD PDF CATALOG

Whether you're an architect, designer, hotelier, or homeowner with a vision—ALBiDAY is here to bring your ideas to life.



## LINE OFFICIAL

Leaving the the message and more comfortable for discussion



**TEL: 081-544-1180**

Hotline bling to contact us anytime



[CONTACT@ALBIDAY.COM](mailto:CONTACT@ALBIDAY.COM)



[ALBIDAY\\_](#)



[WWW.ALBIDAY.COM](http://WWW.ALBIDAY.COM)

CONTACT US-  
DESIGN WITH INTENTION

# ALBiDAY

B A G K O K

BRING THE WORLD  
BACK HOME TO YOU

ICHATIM CO., LTD.

**ALBiDAY**  
BAGKOK

**Bringing the World  
Back Home  
to You**

**WWW.ALBIDAY.COM**